

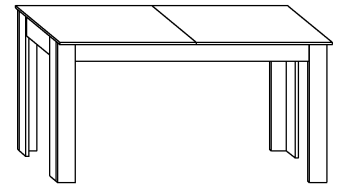

STÓŁ KUCHENNY ROZKŁADANY

→ 120/160 ↑ 76 ↘ 80



x 36



(a)

x 16

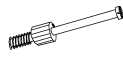

(b)

x 16



(c)

x 4



(d)

x 2



(e)

x 8

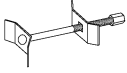

(f)

x 2

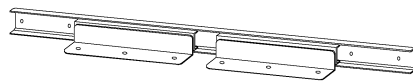

(g)

x 4



(h)

x 2



(i)

x 2



(j)

x 8



(k)

x 12
(6,2x13)



(l)

x 8
(3x13)



(m)

x 24
(4x16)



(n)

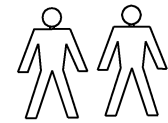

60 min

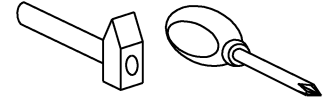

1 - FAZY MONTAŻU

A - OZNACZENIE ELEMENTÓW

a - OZNACZENIE AKCESORIÓW

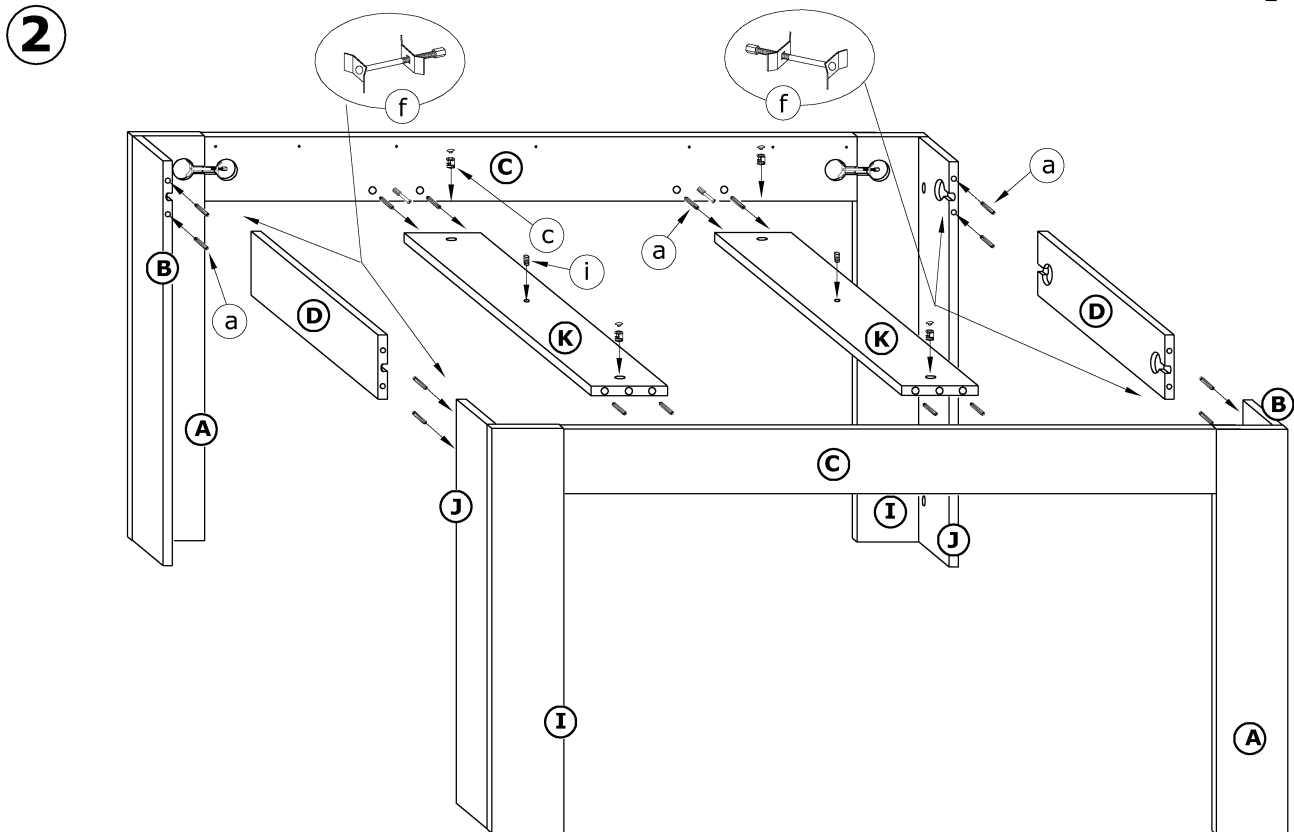
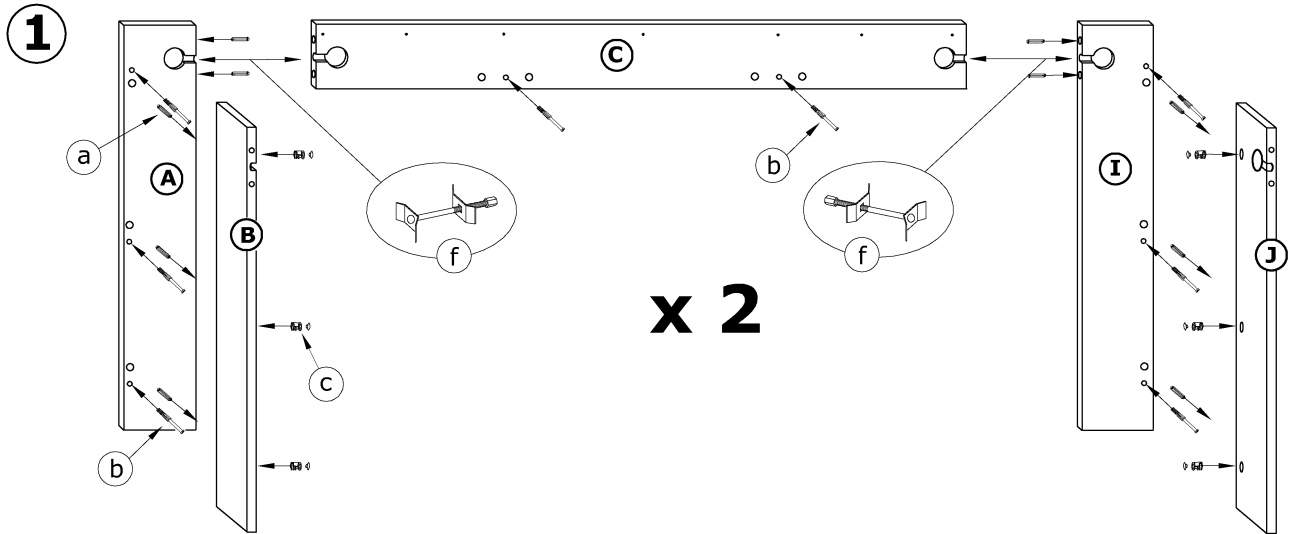

3

